

FG 192/VW1B

**Chiave tendicinghia
VW, AUDI, SEAT, SKODA**

~~23,00€~~ **13,90€**



FG 192/VW1C

**Chiave tendicinghia
VW, AUDI, SEAT, SKODA**

~~13,90€~~ **13,90€**



FG 192/VW1D

**Chiave tendicinghia
VW, AUDI, SEAT, SKODA**

~~26,00€~~ **15,90€**



FG 192/VW1E

**Chiave tendicinghia
VW, AUDI, SEAT, SKODA**

~~36,00€~~ **21,90€**



FG 192/VW1F

**Attrezzo bloccaggio
pignone albero a camme
VW, AUDI, SEAT, SKODA**

~~79,00€~~ **47,50€**



FG 192/VW5B

**Set fasatura motori
AUDI 3.0 V6 A CINGHIA - Benzina**

Modelli:
AUDI: A4, A4 Cabrio,
A4 quattro, A6, A8

Cilindrata: 3.0 Benzina
Codice motore: ASN, BBJ

~~245,00€~~ **149,00€**

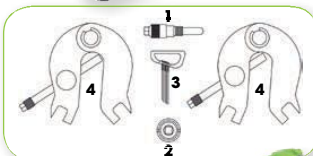

CONTENUTO
FG 192/VW5B-1 Attrezzo bloccaggio albero motore
FG 192/VW5B-2 Attrezzo di registrazione del pignone albero a camme
FG 192/VW5B-3 Perno di bloccaggio del tendicinghia
FG 192/VW5B-4 Attrezzi di bloccaggio albero a camme (2 pezzi)



FG 192/VW4B

**Set fasatura motori
VAG 1.0 3 cilindri**

Modelli:
SEAT: Mii
SKODA: Citigo, Fabia
VOLKSWAGEN: Up, Polo

Cilindrata: 1.0 Benzina
Codice motore: CHYA, CHYB,
CPGA

~~190,00€~~ **115,00€**

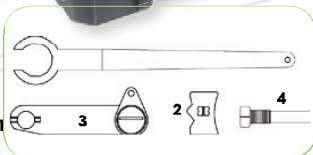

CONTENUTO
FG 192/VW4B-1 Attrezzo bloccaggio puleggia del tendicinghia
FG 192/VW4B-2 Attrezzo bloccaggio albero a camme
FG 192/VW4B-3 Attrezzo fasatura albero a camme
FG 192/VW4B-4 Attrezzo bloccaggio albero motore

FG 192/VW2

**Utensili per allineamento albero a camme
motori VOLKSWAGEN, AUDI, SKODA 1.2 TSI**

Modelli:
VOLKSWAGEN: Beetle/Maggiolino, Caddy/
Caddy Maxi, Golf Plus, Golf VI, Golf VI Cabrio,
Golf VI Estate, Jetta, Polo, Touran
AUDI: A1, A2, A3 Cabrio
SEAT: Altea/Altea XL, Ibiza, Leon
SKODA: Fabia II, Octavia, Praktik, Roomster, Yeti

Cilindrata: 1.2 TSI BENZINA
Codice motore: CBZA, CBZB, CBZC

~~55,00€~~ **32,90€**



FG 192/VW4

**Set fasatura motori
VAG 1.2 3 cilindros 6v e 12v**

Modelli:
Volkswagen: Polo, Fox
Seat: Cordoba, Ibiza
Skoda: Fabia, Roomster
Seat: Cordoba, Ibiza
Cilindrata: 1.2 3 Cil. 6V e 12V
Codice motore: AWY, BMD, AZQ, BME

~~105,00€~~ **59,00€**

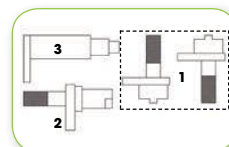

CONTENUTO
FG 192/VW4-1 Attrezzo di allineamento albero a camme x 2
FG 192/VW4-2 Attrezzo di allineamento albero a camme
FG 192/VW4-3



FG 192/VW1

**Utensile bloccaggio puleggia
VAG 1.4 16V e 1.6 16V**

Modelli:
Volkswagen: Polo, Lupo, Bora, Golf,
Golf Estate, Caddy, Caddy Maxi,
Polo Classic, Beetle
Skoda: Fabia, Octavia, Octavia Tour,
Octavia II
Seat: Cordoba, Ibiza, Arosatoledo,
Leon, Inca
Audi: A2

Cilindrata: 1.4 16V e 1.6 16V
Codici motore: AFH, AFK, AHW, AJV,
AKQ, APE, AQQ, ATN, AUA, AUB, AUS,
AXP, AZD, BAD, BBY, BBZ, BCA, BCB, BKY

~~45,00€~~ **26,90€**





FG 192/VW3

Set fasatura motori VW, AUDI, SKODA-SEAT 1.4 FSI & 1.6 FSI

Modelli:
A3, Polo, Golf, Golf Plus, Touran, Eos, Jetta, Passat, Octavia II

Cilindrata: 1.4 FSI & 1.6 FSI
Codice motore: AUX, BAG, BKG, BLF, BLN, BLP

~~135,00€~~ **79,90€**

CONTENUTO
FG 192/VW3-1 Supporto comparatore
FG 192/VW3-2 Altrrezzo di allineamento albero a comme
FG 192/VW3-3 Perno di bloccaggio tendicateno
FG 192/VW3-4 Altrrezzo di bloccaggio albero motore

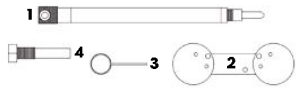

FG 192/VW4C

Set fasatura motori VAG 1.2/1.4 TSI e TFSI

Modelli:
A3, A3 Sportback, A3 Saloon, A3 Cabrio, A3 Sedan, A1, A1 Sportback, Q3 Leon, Leon ST, Ibiza Fabia III, Fabia III Estate, Octavia III Polo, Jetta, Golf VII, Golf VII Estate, Golf VII Wagon, Passat, Golf SV

Cilindrata: 1.2 TSI, 1.2 TFSI, 1.4 TSI, 1.4 TFSI, 1.4 TSI ACT, 1.4 GTE, 1.4 GTE Hybrid, 1.4 TFSI COD, 1.4 TGI BlueMotion, 1.4g-tron, 1.4e-tron
Codice motore: CJZA, CJZB, CJZC, CJZD, CYVD, CYVA, CYVB, CZCA, CXSA, CXSB, CPWA, CHPB, CUKB, CZDA, CPTA, CZEA

~~220,00€~~ **132,00€**

NEW

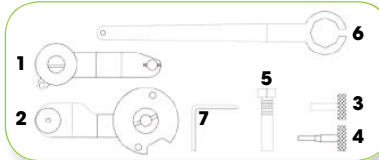

CONTENUTO
FG 192/VW4C-1 Altrrezzo di fasatura albero a comme
FG 192/VW4C-2 Altrrezzo di fasatura albero a comme
FG 192/VW4C-3 Perno bloccaggio albero a comme
FG 192/VW4C-4 Perno di controllo fasatura albero a comme
FG 192/VW4C-5 Altrrezzo bloccaggio albero motore
FG 192/VW4C-6 Altrrezzo bloccaggio puleggia del tendicateno
FG 192/VW4C-7 Perno bloccaggio tendicateno degli organi ausiliari



FG 192/VW5

Set fasatura motori VAG 1.8 e 1.8T

Modelli:
AUDI: A3; S3; TT; A6
SEAT: Ibiza; Cordoba; Leon; Toledo; Alhambra Octavia
VW: Golf; Passat

Cilindrata: 1.8, 1.8 T benzina

Codice motore: ADR, AEB, AFY, AGN, AGU, AJH, AJL, AJP, AJQ, AMK, AMU, ANB, APG, APH, APP, APT, APU, APX, APY, AQA, AQX, AGR, ARX, ARY, ARZ, ATC, ATW, AUM, AUQ, AVC, AWC, AWP, AWU, AWW, AYP, BAM, BEA, BFV, BKF, BNU, BVP, BVR

~~34,00€~~ **19,90€**



FG 192/VW8

Set fasatura motori VAG 1.8/2.0 TFSI 4V (CATENA)

Modelli:
VW: Tiguan; CC; Golf VI; Passat; Beetle/Maggiolino; Eos; Scirocco.
AUDI: A4; A4 quattro; A5 Coupe e Cabriolet; A5 Sportback; Q5; TT
SKODA: Octavia II; Superb; Yeti
Cilindrata: 1.8 TFSI; 2.0 TFSI
Codice motore: CCZA; CCZB; CCZC; CCZD; CDAA; CDAB; CDHB; CDNC; CFKA; CDNB; CETA; CJEB; CESA; CDHA

~~260,00€~~ **155,00€**

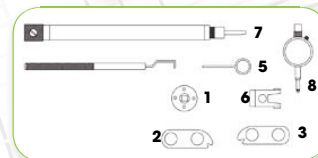

CONTENUTO
FG 192/VW8-1 Altrrezzo rimozione valvola controllo albero a comme
FG 192/VW8-2 Morsa albero a comme (scarico)
FG 192/VW8-3 Morsa albero a comme (aspirazione)
FG 192/VW8-4 Perno bloccaggio del tendicateno della pompa dell'olio
FG 192/VW8-5 Perno di bloccaggio del tendicateno 1,4 mm
FG 192/VW8-6 Tendicateno di distribuzione
FG 192/VW8-7 Indicatore PMS
FG 192/VW8-8 Comparatore



FG 192/VW7C

Set fasatura motori VW/AUDI 2.0 FSI & TFSI Catena della distribuzione nella testata

Modelli:
AUDI: A3, A4, TT, A4 Cabrio, S3
VOLKSWAGEN: Golf VI, Touran, Passat, Eos, Jetta, Golf Plus, Scirocco, Golf V
Cilindrata: 2.0, 2.0 FSI, 2.0 TFSI
Codice motore: AXW, BHD, BMB, AWA, AXX, BPY, BWA, BUL, BPJ, BGB, BWE, BLR, BLX, BLY, BVY, BWT, BPG, CDLA, CDLB, CDLC, CDMA, AXW, CDLF

~~160,00€~~ **95,00€**

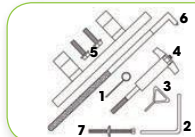

CONTENUTO
FG 192/VW7C-1 Perno di bloccaggio del tendicateno
FG 192/VW7C-2 Perno di bloccaggio del tendicateno della cinghia organi ausiliari
FG 192/VW7C-3 Perno di bloccaggio del tendicateno
FG 192/VW7C-4 Altrrezzo di fissaggio dispositivo di registrazione albero a comme/tendicateno
FG 192/VW7C-5 Altrrezzo allineamento albero a comme
FG 192/VW7C-6 Chiave a due denti
FG 192/VW7C-7 Perno bloccaggio albero equilibratore

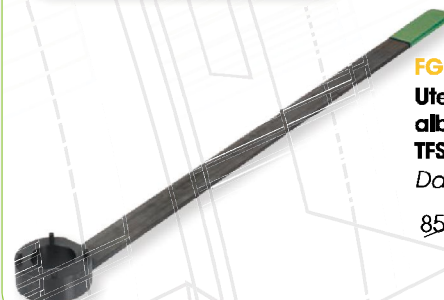

FG 192/VW8B

Utensile bloccaggio puleggia albero motore VAG 1.8/2.0 TFSI 4V (CATENA)

Da associare a FG 192/VW8

~~85,00€~~ **49,00€**



FG 192/VW7D

Set fasatura motori AUDI 2.5 TFSI / RS PLUS

Modelli:
RS Q3; Q3; TT
Cilindrata: 2.5 TFSI / RS PLUS
Codici motore: CZGA; CZGB; CEPA; CEPB; CTA

~~290,00€~~ **175,00€** **NEW**

CONTENUTO
FG 192/VW7D-1 Altrrezzo bloccaggio dispositivo registrazione albero a comme
FG 192/VW7D-2 Perno allineamento albero motore
FG 192/VW7D-3 Adattatore del bullone della puleggia dell'albero motore
FG 192/VW7D-4 Perno bloccaggio tendicateno (3 pezzi)
FG 192/VW7D-5 Altrrezzo bloccaggio albero a comme (2 pezzi)
FG 192/VW7D-6

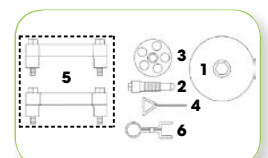



FG 192/VW108
Set fasatura nuovi motori
VAG 1.4, 1.6, 2.0 TDi CR



Modelli:
Volkswagen: Golf VII, Golf VII Estate, Golf VII Wagon, Polo
Audi: A3 Cabrio, A3 Saloon, A3/A3 Sportback, A4, A4 allroad, A4 quattro, A5 Coupe/Cabriolet, A5 Sportback, A6, Q5, TT
Seat: Leon, Leon ST
Skoda: Octavia III

Cilindrata: 1.4TDI CR, 1.6TDI CR, 1.6TDI CR GreenLine/BlueMotion/Ecomotive, 2.0TDI CR/RS TDI/TDI CR Ultra

Codici motore: CKFB, CKFC, CLHA, CLHB, CNHA, CNHC, CRBC, CRBD, CRFA, CRFC, CRKA, CRKB, CRLB, CRLC, CRMB, CRVA, CRVC, CSUA, CSUB, CUNA, CUPA, CUTA, CUSA, CUSB

~~290,00€~~ **175,00€**

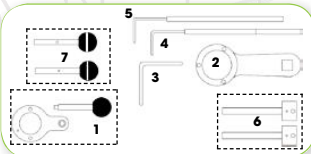

CONTENUTO
FG 192/VW108-1 Attrezzo bloccaggio pignone albero motore
FG 192/VW108-2 Attrezzo bloccaggio pignone pompa carburante alla pressione
FG 192/VW108-3 Perno bloccaggio tendicinghia dello cinghia organi ausiliari
FG 192/VW108-4 Attrezzo di registrazione puleggia del tendicinghia
FG 192/VW108-5 Attrezzo bloccaggio puleggia del tendicinghia
FG 192/VW108-6 Perno bloccaggio pompa carburante alla pressione
FG 192/VW108-7 Attrezzo di bloccaggio albero a camme

FG 192/VW11

Set rimontaggio alberi a camme all'interno della testata VW, AUDI, SEAT, SKODA 1.6, 2.0 TDI CR

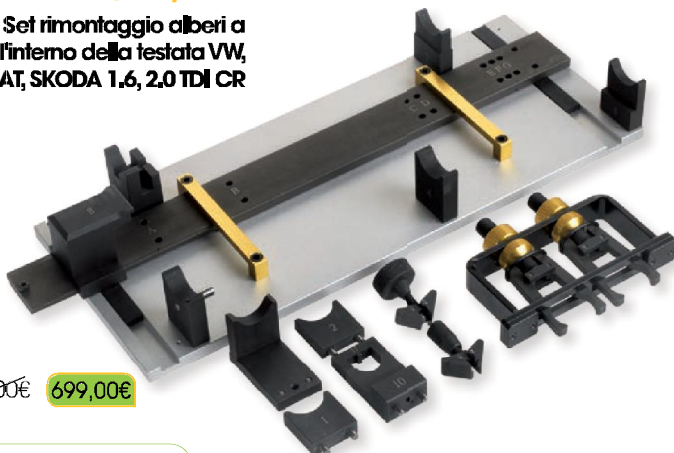

~~1.200,00€~~ **699,00€**

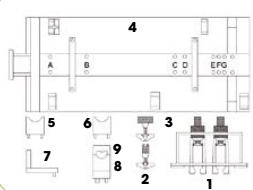

CONTENUTO
FG 192/VW11-1 Attrezzo bloccaggio alberi a camme
FG 192/VW11-2 Attrezzo allineamento in gronaggio albero a camme di scarico
FG 192/VW11-3 Attrezzo di allineamento in gronaggio a due pezzi
FG 192/VW11-4 Piastra base attrezzo di allineamento alberi a camme
FG 192/VW11-5 Supporto attrezzo di allineamento alberi a camme
FG 192/VW11-6 Supporto attrezzo di allineamento alberi a camme
FG 192/VW11-7 Supporto attrezzo di allineamento alberi a camme
FG 192/VW11-8 Supporto attrezzo di allineamento alberi a camme
FG 192/VW11-9 Supporto attrezzo di allineamento alberi a camme



FG 192/VW6
Set fasatura motori
VOIKSWAGEN 2.5 TDI PD



Modelli:
Transporter, Tuareg

Cilindrata: 2.5 TDI PD
Codici motore:
AXD; AXE; BAC; BLJ; BLK; BNZ; BPC; BPD; BPE

~~410,00€~~ **245,00€**

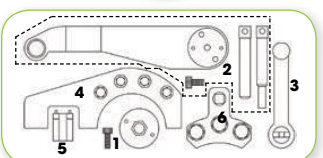

CONTENUTO
FG 192/VW6-1 Attrezzo di allineamento albero motore
FG 192/VW6-2 Attrezzo di bloccaggio albero motore
FG 192/VW6-3 Attrezzo di allineamento albero a camme
FG 192/VW6-4 Attrezzo di bloccaggio ingranaggio albero a camme
FG 192/VW6-5 Attrezzo di pretensionamento ingranaggio di compensazione albero a camme
FG 192/VW6-6 Attrezzo di bloccaggio barra rotazione ingranaggio albero a camme



FG 192/VW7
Set fasatura VW 1.2,1.4,1.6,1.9,2.0D TDI PD



Modelli:
Volkswagen: Bora, Golf, Golf Estate, Golf Plus, Passat, Lupo, Polo, Sharan, Beetle, Touran, Transporter, Jetta, Caddy, Caddy Maxi, Eos
Audi: A2, A3, A4, A4 Cabrio, A4 Quattro, A6
Seat: Arosa, Cordoba, Ibiza, Alhambra, Leon, Toledo, Altea, Altea XI
Skoda: Fabia, Octavia, Octavia Tour, Octavia II, Superb, Roomster

Cilindrata: 1.2D TDI PD, 1.4D TDI PD, 1.6D TDI PD, 1.9D TDI PD, 2.0D TDI PD
Codici motore: AJM, AMF, ANU, ANY, ARL, ASZ, ATD, ATJ, ATL, AUU, AVB, AVF, AVQ, AWX, AXB, AXC, AXR, AYZ, AZY, BAY, BDJ, BDK, BGW, BHC, BHW, BJB, BKC, BKD, BKE, BKP, BKQ, BLB, BLS, BLT, BMA, BMM, BMN, BMP, BMR, BMS, BMT, BNA, BNM, BNV, BPW, BPX, BRA, BRB, BRC, BRE, BRF, BRM, BRT, BRU, BSS, BSV, BSU, BSW, BTB, BUK, BUY, BUZ, BVA, BVE, BVF, BVG, BVH, BVK, BWV, BXE, BXF

~~95,00€~~ **56,90€**

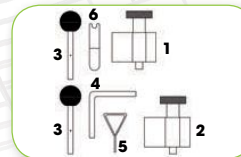

CONTENUTO
FG 192/VW7-1 Attrezzo bloccaggio del pignone fondo albero motore
FG 192/VW7-2 Attrezzo bloccaggio del pignone ovale albero motore
FG 192/VW7-3 Attrezzo di bloccaggio albero a camme (2 pezzi)
FG 192/VW7-4 Perno bloccaggio del tendicinghia dello cinghia organi ausiliari
FG 192/VW7-5 Perno bloccaggio della puleggia del tendicinghia
FG 192/VW7-6 Chiave a due denti

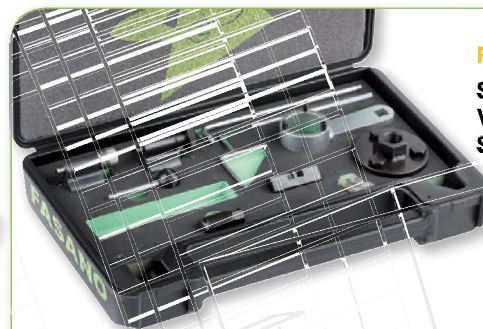

FG 192/VW10
Set fasatura motori
VW, AUDI, SEAT,
SKODA 1.6, 2.0 TDI CR

~~230,00€~~ **139,00€**



Modelli:
VW: Beetle/Maggiolino; Golf V; Golf VI Cabri; Golf VI Estate; Golf Plus; Passat; Polo; Jetta; Touran; Caddy/Caddy Maxi
Audi: Q5; A1; A3; A3 Cabrio; A4; A4 allroad; A4 quattro; A5 Coupe/Cabriolet; A5 Sportback; A6
Seat: Ibiza; Leon; Altea / Altea XL; Toledo; Exeo
Skoda: Fabia II; Octavia II; Rapid; Praktik; Yeti; Roomster; Superb II

Cilindrata: 1.6, 2.0 TDI CR (diesel a cinghia)
Codici motore: CAYB; CAYC; CAYA; CAGA; CAGB; CAGC; CAHA; CAHB; CFHC; CBAA; CBAB; CFFB; CGLA; CGLB; CAAA; CAAB; CAAC; CBAB; CBAC; CBBA; CBBB; CBDA; CBDB; CBDC; CFJA; CFWA; CJCA; CJCB; CJAA; CCHA; CEGA

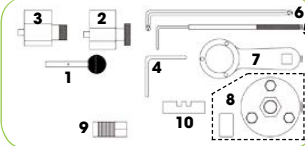

CONTENUTO
FG 192/VW10-1 Attrezzo bloccaggio albero a camme/pompa carburante
FG 192/VW10-2 Attrezzo di bloccaggio del pignone albero motore
FG 192/VW10-3 Attrezzo di bloccaggio del pignone albero motore
FG 192/VW10-4 Perno bloccaggio tendicinghia organi ausiliari (3,9 mm)
FG 192/VW10-5 Attrezzo di bloccaggio della puleggia del tendicinghia
FG 192/VW10-6 Attrezzo registrazione puleggia del tendicinghia
FG 192/VW10-7 Attrezzo bloccaggio mezzo pignone albero a camme
FG 192/VW10-8 Estrattore mezzo pignone albero a camme
FG 192/VW10-9 Estrattore mezzo pignone albero a camme
FG 192/VW10-10 Attrezzo di bloccaggio albero equilibratore



FG 192/VW6B
Set rimozione POMPA DELL'ACQUA
motori VOLKSWAGEN 2.5 TDI PD



Modelli:
Transporter, Transporter T5, Touareg
Cilindrata: 2.5 TDI PD
Codici motore: AXD, AXE, BAC, BLJ, BLK, BNZ, BPC, BPD

95,00€

CONTENUTO
FG 192/VW6B-1 Estrattore ingranaggio pompa dell'acqua
FG 192/VW6B-2 Estrattore pompa dell'acqua
FG 192/VW6B-3 Attrezzo di allineamento albero motore

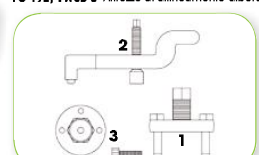



FG 192/VW7B Set fasatura motori VOLKSWAGEN 2.4, 2.5 TDI

Modelli:
LT; Crafter; Transporter T4

Cilindrata: 2.4, 2.5 Tdi
Codici motore: ANJ; BJJ; BJK; BJI;
BJM; AAB; AJA

~~150,00€~~ **89,00€**

- CONTENUTO**
FG 192/VW7B-1 Barra di bloccaggio albero a camme
FG 192/VW7B-2 Perno bloccaggio pignone pompa iniezione Ø15.4 mm
FG 192/VW7B-3 Spessori
FG 192/VW7B-4 Attrezzo di bloccaggio della puleggia albero motore
FG 192/VW7B-5 Chiave per la puleggia del tendicinghia
FG 192/VW7B-6 Perno di fasatura albero motore

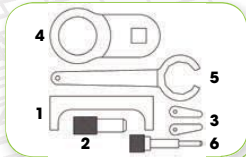

FG 192/VW14 Set fasatura motori VAG & FORD

Modelli:
Volkswagen: Transporter, Caddy, Golf, Golf Estate, Passat, Polo, Polo Classic, Polo Estate, Sharan, Vento, Bora, Beetle, Lupo
Audi: 80, 90, 100, A6, A3, A4, A8, Allroad
Seat: Cordoba, Ibiza, Toledo, Alhambra, Inca, Arosa
Skoda: Felicia, Van, Pick-Up, Octavia, Octavia Tour, Fabia
Ford: Galaxy

~~232,00€~~ **139,00€**

Cilindrata: 1.2D TDI PD, 1.4D TDI PD, 1.6, 1.6D, 1.6D TURBO, 1.7D SDI, 1.8, 1.8 TURBO, 1.9D, 1.9D TURBO, 1.9D TDI, 1.9D TDI PD, 2.0, 2.4D, 2.5D TDI, 2.5D SDI, 3.7, 4.2

Codici motore: 1X, 1Y, 1Z, AAB, AAT, AAZ, ABL, ABZ, ACE, ACV, ADP, ADR, AEB, AEF, AEL, AEY, AEW, AFB, AFF, AFN, AGD, AGP, AGR, AGX, AHB, AHC, AHD, AHF, AHH, AHL, AHU, AJA, AJM, AKE, AKN, AKU, AKW, ALE, ALH, ALT, AMF, ANU, ANY, AQM, ARL, ASV, ASX, ASZ, ATD, ATJ, AUJ, AVB, AVF, AVG, AVJ, AWX, AXR, AYM, AYZ, BAY, CY, JK, RA, SB

- CONTENUTO**
FG 192/VW14-1 Guide 8 mm (2 pz)
FG 192/VW14-2 Attrezzo bloccaggio del pignone albero motore
FG 192/VW14-3 Chiave a due denti
FG 192/VW14-4 Attrezzo bloccaggio albero a camme
FG 192/VW14-5 Chiave bloccaggio del tendicinghia
FG 192/VW14-6 Perno di bloccaggio del pignone pompa d'iniezione
FG 192/VW14-7 Barra di bloccaggio albero a camme
FG 192/VW14-8 Attrezzo bloccaggio albero motore
FG 192/VW14-9 Perno di bloccaggio
FG 192/VW14-10 Attrezzi allineamento albero a camme
FG 192/VW14-11 Barra di bloccaggio albero a camme
FG 192/VW14-12 Barra di bloccaggio albero a camme

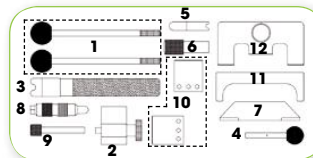

FG 192/VW12 Set fasatura motori VOLKSWAGEN/AUDI 2.7D, 3.0D Tdi V6, 4.0D, 4.2D Tdi V8 (CATENA DELLA DISTRIBUZIONE)

Modelli:
AUDI: A4, A4 Cabrio, A6, A6 allroad, A5 Coupe/
Cabriolet, A5 Sportback, A8, Q7, Q5, A5 Coupe/
Cabriolet

Cilindrata: 2.7TDI, 2.7TDI CR, 3.0TDI, 3.0TDI CR, 4.0TDI CR, 4.2TDI CR
Codici motore: BPP, BSG, CAMA, CAMB, CANA, CANB, CANS, CAND, CGKA, CGKB, ASB, BKN, BMK, BMZ, BNG, BUG, CAPA: CASA, CASB, CCLA, CCMA, CCWA, CCWB, CDTA, CDTB, CDUC, CDYA, CDYB, CDYC, CJGA, CJGC, CKVB, CKVC, CLAA, CLAB, CLZB, ASE, BVN, CDSB, CCFA, BTR

~~159,00€~~ **159,00€**

- CONTENUTO**
FG 192/VW12-1 Attrezzo di rotazione albero motore (TIPO 1)
FG 192/VW12-2 Perno di bloccaggio albero a camme (2 pezzi)
FG 192/VW12-3 Perno bloccaggio sterzello tendicinghia (Ø 3.3mm) - (2pz)
FG 192/VW12-4 Attrezzo di allineamento/bloccaggio albero a camme
FG 192/VW12-5 Attrezzo di bloccaggio pignone albero a camme
FG 192/VW12-6 Attrezzo di rotazione albero motore (TIPO 2)
FG 192/VW12-7 Perno di bloccaggio tendicinghia (3 pezzi)
FG 192/VW12-8 Attrezzo bloccaggio pignone pompa carburante ad alta pressione
FG 192/VW12-9 Attrezzo bloccaggio albero motore
FG 192/VW12-10 Attrezzo bloccaggio albero equilibratore pompa di iniezione

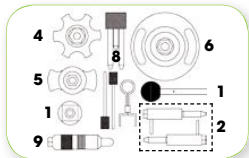

FG 192/VW9 Set fasatura motori VAG 2.5 Tdi V6 - a cinghia

Modelli:
Volkswagen: Passat
Audi: A4; A4 quattro; A6; A6 quattro;
A8; Allroad; A4 Cabrio
Skoda: Superb
Cilindrata: 2.5 Tdi
Codici motore: AFB; BAU; AKE;
AKN; BDG; BDH; AFB; BAU; AKE;
AKN; AYM; BCZ; BDG; BDH; BFC;
AYM; BDG

~~110,00€~~ **65,00€**

- CODICE**
FG 192/VW9-1 Guide di supporto
FG 192/VW9-2 Perno bloccaggio tendicinghia
FG 192/VW9-3 Chiave per tendicinghia
FG 192/VW9-4 Attrezzo di allineamento albero a camme
FG 192/VW9-5 Attrezzo di bloccaggio albero motore
FG 192/VW9-6 Perno di bloccaggio della pompa d'iniezione

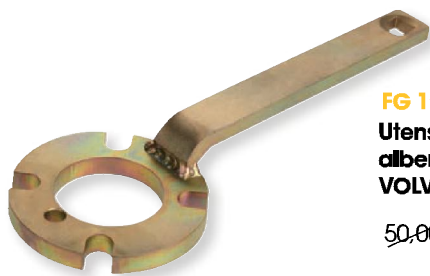
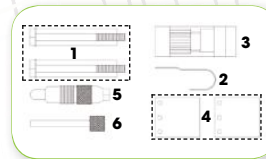

FG 192/VO1 Utensile supporto puleggia albero motore adatto per motori VOLVO DIESEL/BENZINA

~~50,00€~~ **29,90€**



FG 192/PM Testatore per la ricerca del punto morto superiore

~~65,00€~~ **39,00€**



L/mm
L1/mm

L: 230mm
L1: 43mm
M: 14x1.25



FG 192/CO Comparatore universale

Range: 0-8mm
Lettura: 0.01mm

~~80,00€~~ **48,00€**



FG 192/CE Utensile per installazione e rimozione cinghie elastiche

~~60,00€~~ **36,00€**





FG 184/BP
Set universale per bloccaggio pulegge distribuzione

~~190,00€~~ **109,00€**



FG 184/S24
Set universale montaggio e smontaggio maglie catene di distribuzione

~~350,00€~~ **209,00€**

FG 184/CP
Chiave per rotazione pulegge di distribuzione

~~60,00€~~ **35,00€**



FG 184/S5
Set 5 chiavi per dadi tendicinghia

59,00€



Torx

FG 184TX/S5
Set 5 chiavi per dadi tendicinghia TORX

~~155,00€~~ **89,00€**

ESTRATTORI PULEGGE MULTIGOLA

FG 181/PS
Estrattore per pulegge multigola

~~105,00€~~ **59,00€**

- Capacità 40-90mm
- Griffe ultra sottili

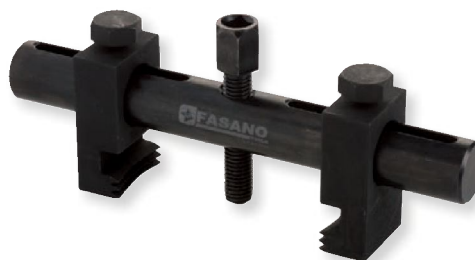

FG 181/PM
Estrattore per pulegge multigola

79,00€

- Capacità: 30-157mm
- Passo gola: 3.56mm
- Griffe regolabili



SPECIALE

AUTO ASIATICHE

Un intenso periodo di studio e ricerca ha portato alla nascita di una sezione di prodotto per la fasatura motore interamente dedicata alle vetture asiatiche.

Anche in questo caso i kit sono dotati di un accurato MANUALE D'USO, con l'esatta corrispondenza tra codici FASANO Tools e codici OEM, e istruzioni precise per l'utilizzo dei vari set.



NEW 

FG 192/HO5

Set fasatura motori Honda 1.6-3.0 (SOHC e DOHC)

Modelli:
Civic; Accord; Prulde; Shuttle; Odyssey

Cilindrata: 1.6, 1.8, 2.0, 2.2; 2.3; 3.0

Codici motore:

1.6: B16A2

1.8: F18A3, F18B2, F18B4

2.0: F20AF, F20B3, F20B5, F20B6, F20B7, F20Z1, F22Z2, F22B5, F22B8, F22A2, H22A5, H22A7, H22A8

2.3: F23A7, F23Z5, H23A2, H23A3

3.0: J30A1



~~50,00€~~
49,00€

NEW 

FG 192/DW2

Coppia di chiavi a forchetta 41 mm per pompa dell'acqua motori Chevrolet, Daewoo

Modelli:

Chevrolet: Aveo, Cruze, Kalos, Lacetti, Tacuma/Rezzo, Nubira

Daewoo: Kalos, Lacetti, Lanos, Nubira, Nexia/Cielo/Racer, Tacuma/Rezzo

Cilindrata: 1.4, 1.5, 1.6, 1.8

Codici motore: F14D3, F16D3, A16DMS, G15MF, A15MF, F14S3, A15DM, A15SMS, A16DM, F18N



~~65,00€~~
51,90€

NEW 

FG 192/HI5

Set tendicinghia motori Hyundai, Mitsubishi e Proton

Modelli:

Hyundai: Lantra/Elantra; Sonata; Santa Fe; Trajet

Mitsubishi: 3000 GT; Colt; Lancer; Carisma; Space Star; Pajero Pinin; Galant; Space runner; Grandis; Triton

Proton: Persona; 418; Satria; Wira; M21 Coupe

Cilindrata: 1.6, 1.8, 2.0, 2.4, 3.0, 3.5

Codici motore:

1.6: 4G61, G4-R - 1.8: 4G67, 4G93, 4G93P, G4-N

2.0: 4G63, 4G94, G4CP, G4JP, G4P

2.4: 4G64, 4G69, G4JS

3.0: 6G72 - 3.5: 6G74



~~50,00€~~

29,90€

FG 192/TY15

Attrezzo bloccaggio puleggia albero motore e albero a camme



Modelli:

Lexus: GS; LS; LX; RX

Toyota: Auris; Avensis; Corolla; Aygo; Celica; Corolla Verso/CombiVan

Cilindrata:

1.0; 1.3; 1.4; 1.6; 2.0; 2.2; 2.4; 2.5; 2.7; 2.8; 3.0; 3.4; 3.5; 4.7

Codici motore:

1UZ-FE; 1MZ-FE; 3MZ-FE; 3UZ-FE; 4ZZ-FE; 1CD-FTV; 1ZZ-FE; 3ZZ-FE; 2ZZ-GE; 2KD-FTV; 2KD-FTV H; 2KD-FTV L; 1KD-FTV; 2UZ-FE; 2SZ-FE



NEW

~~72,00€~~
72,00€



FG 192/TY45

Set fasatura motori Toyota, Lexus



Modelli:

Toyota: 4-Runner, Auris, Avensis, Camry, Celica, Corolla, Corolla Verso/CombiVan, Dyna, Hiace, Hilux, Landcruiser, Landcruiser/Prado, MR2, Picnic/SportVan, Previa, Prius, RAV4, Starlet, Tarago, Verso, Verso/Sportsvan, Vienta, Yaris

Lexus: GS, IS, LS, LX, RX, SC

Cilindrata:

1.0, 1.3, 1.4, 1.6, 2.0, 2.2, 2.4, 2.5, 2.7, 2.8, 3.0, 3.4, 3.5, 4.7

Codici motore:

1SZ-FE, 2SZ-FE, 4G15, 4G93, 2ZR-FAE, 1ZZ-FE, 2AD-FHV, 2AD-FTV, 1AD-FTV, 1CD-FTV, 1MZ-FE, 4E-FE, 2L, 3ZZ-FE, 4ZZ-FE, 3L, 2TR-FE, 2KD-FTV, 2LT, 1GR-FE, 5VZ-FE, 5L, 2ZR-FE

~~490,00€~~ 290,00€

NEW

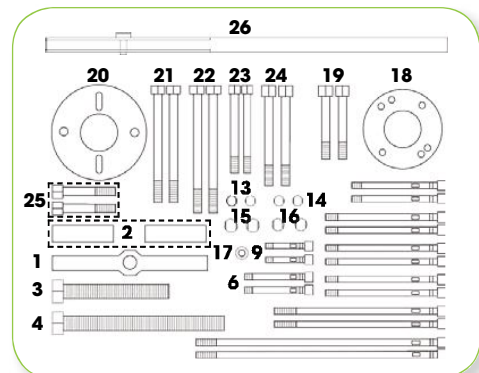

CONTENUTO

- FG 192/TY45-10 Vite M8x100 (2 pezzi)
- FG 192/TY45-11 Vite M8x75 (2 pezzi)
- FG 192/TY45-12 Vite M8x25 (2 pezzi)
- FG 192/TY45-13 Adattatore M10x1.25 (2 pezzi)
- FG 192/TY45-14 Adattatore M12x1.25 (2 pezzi)
- FG 192/TY45-15 Adattatore M12x1.25 (2 pezzi)
- FG 192/TY45-16 Adattatore
- FG 192/TY45-17 Estiratore puleggia albero motore
- FG 192/TY45-18 Vite M8x5 per estrattore 18 (2 pezzi)
- FG 192/TY45-19 Estiratore puleggia albero motore
- FG 192/TY45-20 Vite M8x106 per estrattore 20 (2 pezzi)
- FG 192/TY45-21 Vite M8x116 per estrattore 20 (2 pezzi)
- FG 192/TY45-22 Vite M8x3 per estrattore 20 (2 pezzi)
- FG 192/TY45-23 Vite M8x8 per estrattore 20 (2 pezzi)
- FG 192/TY45-24 Vite M8x25 per estrattore 20 (2 pezzi)
- FG 192/TY45-25 Vite M8x25 per estrattore 20 (2 pezzi)
- FG 192/TY45-26 Mónico universale

- FG 192/TY45-1 Estiratore albero a camme
- FG 192/TY45-2 Griffe estrattore puleggia albero a camme (2 pezzi)
- FG 192/TY45-3 Vite 100 mm per estrattore 1
- FG 192/TY45-4 Vite 150 mm per estrattore 1
- FG 192/TY45-5 Vite M8x100 (2 pezzi)
- FG 192/TY45-6 Vite M8x50 (2 pezzi)
- FG 192/TY45-7 Vite M8x100 (2 pezzi)
- FG 192/TY45-8 Vite M8x150 (2 pezzi)
- FG 192/TY45-9 Vite M8x30 (2 pezzi)

SPECIALE

VEICOLI PESANTI

A completamento della gamma di utensili speciali per il settore Automotive, si trovano gli utensili specifici per il segmento TRUCK.

Anche in questo caso, in seguito ad un'intensa fase di Ricerca e Sviluppo, FASANO Tools propone la gamma completa di utensili per la rotazione del volano dei mezzi pesanti.



1/2"

FG 197/MB1

Attrezzo per rotazione albero motore Mercedes Benz e MAN - doppio ingranaggio

Modelli:
Merceder-Benz 6, 8, 10 cilindri
MAN 12 cilindri

Codici motore:
401, 404, 407, 409, 421, 424, 444, 427, 447

~~80,00€~~ **49,00€** **NEW**

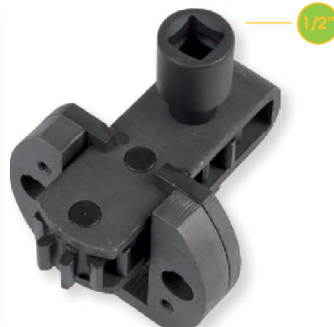

1/2"

FG 197/MB2

Attrezzo per rotazione albero motore Mercedes Benz e MAN - triplo ingranaggio

Modelli:
Merceder-Benz Actros e Atego;
MAN 5, 6, 8 cilindri

~~110,00€~~ **65,00€** **NEW**



1/2"

FG 197/MA1

Attrezzo per rotazione albero motore MAN

Codici motore:
D20..., D25..., D26..., D28...

~~80,00€~~ **49,00€** **NEW**



1/2"

FG 197/SC1

Attrezzo per rotazione albero motore SCANIA

Modelli:
SCANIA (dopo il 1996)

~~60,00€~~ **35,00€** **NEW**



FG 197/VO1

Attrezzo per rotazione albero motore VOLVO

Codici motore:
D9A, D12, D16C

~~70,00€~~ **42,00€** **NEW**



1/2"

26 mm

FG 197/VO2

Attrezzo per rotazione volano albero motore VOLVO e RENAULT

Modelli:
HGV Volvo
RENAULT

Codici motore:
MP8, MP10 (FH, D13A520)

~~60,00€~~ **36,00€** **NEW**



FG 197/IV1

Attrezzo per rotazione albero motore IVECO - doppio ingranaggio

Codici motore: 8040.25.45, 8060.25.45, 260, 8210.42, 8280, 8460, 190.38, 190.42

~~119,00€~~ **119,00€** **NEW**

FG 197/IV2

Attrezzo per rotazione albero motore IVECO - doppio ingranaggio

Codici motore: 8360.46, F3A, F3B

~~209,00€~~ **119,00€** **NEW**



24 mm

FG 197/DA1

Attrezzo per rotazione albero motore DAF

Codici motore:
65CF, 75CF, 85CF, 95XF, CF75, CF85, F65, F75, F85, F95, XF95F95, XF95

~~49,00€~~ **49,00€** **NEW**



1/2"

FG 197/DA2

Attrezzo per rotazione albero motore IVECO

Codici motore: XF105 Euro5

~~50,00€~~ **36,00€** **NEW**